

VANDBORG

125532/
711-226-1020

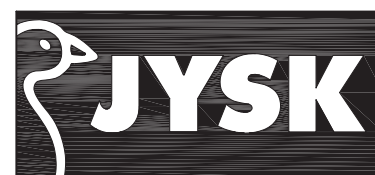

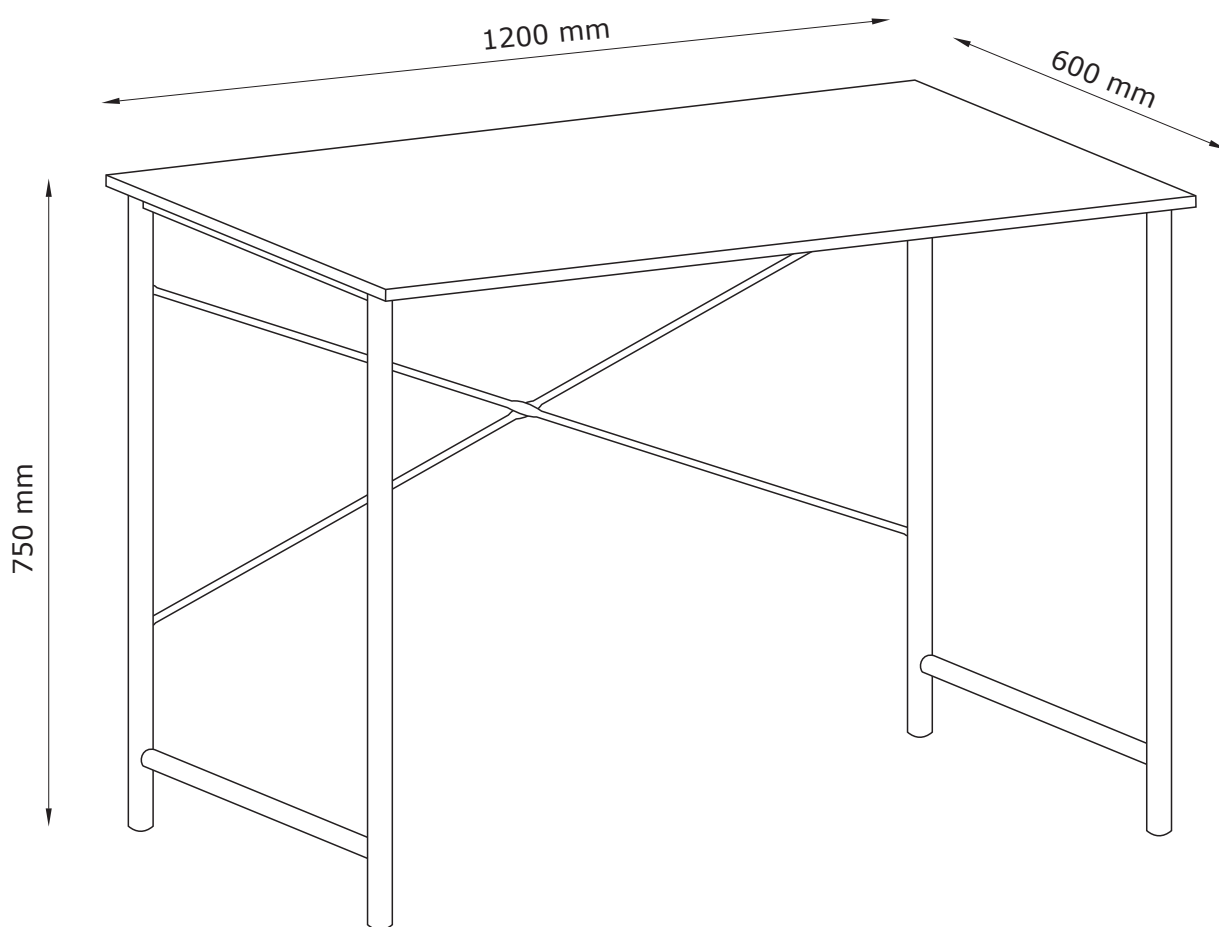
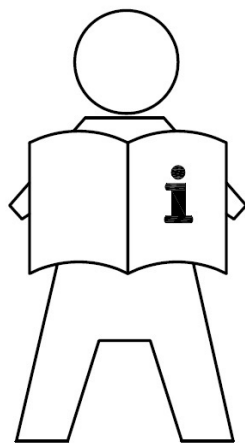

EN: IMPORTANT INFORMATION!

Please read the entire manual carefully before starting to assemble and/or using this product. Follow the manual thoroughly and keep it for further reference.

FR: INFORMATIONS IMPORTANTES

Veillez lire attentivement l'ensemble du manuel avant de commencer à monter et/ou utiliser ce produit. Suivez rigoureusement le manuel et conservez-le pour toute consultation ultérieure.

LV: SVARĪGA INFORMĀCIJA!

Pirms šī izstrādājuma montāžas un/vai lietošanas uzsākšanas pilnībā izlasiet lietošanas pamācību. Stingri ievērojiet pamācības norādījumus un saglabājiet to turpmākai lietošanai.

LT: SVARBI INFORMACIJA!

Prieš pradėdami montuoti gaminį ir (arba) juo naudotis, prašome atidžiai perskaityti visą vadovą. Atidžiai skaitykite vadovą ir turėkite jį su savimi, kad galėtumėte toliau vadovautis jo nuorodomis.

EE: OLULINE TEAVE!

Enne kui alustate toote kokku panemist ja/või kasutamist, lugege see kasutusjuhend hoolikalt läbi. Järgige täpselt juhendis toodud juhiseid ja hoidke juhend alles.

RU: ВАЖНАЯ ИНФОРМАЦИЯ!

Внимательно и полностью прочитайте это руководство, прежде чем приступать к сборке или использованию этого изделия. Следуйте всем инструкциям этого руководства и сохраните его на будущее для справки.

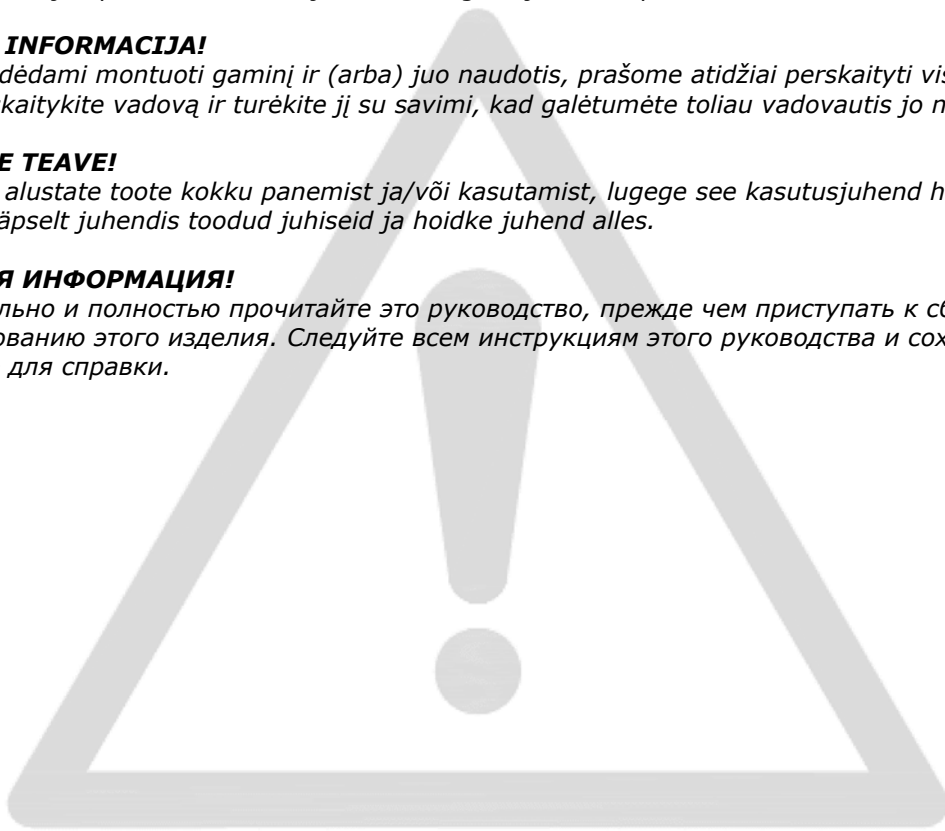

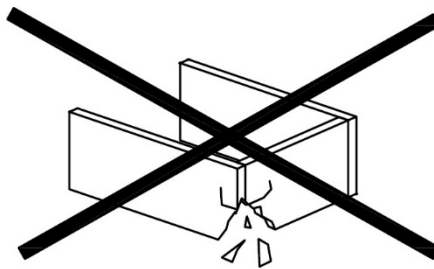
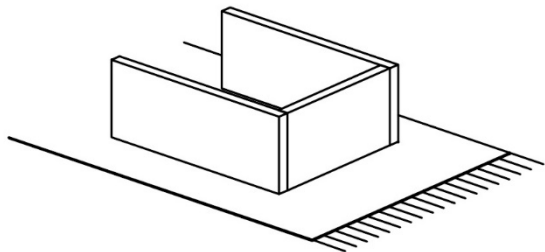

EN: WARNING TO AVOID SCRATCHES!

In order to avoid scratching this furniture should be assembled on a soft layer - could be a rug.

FR: AVERTISSEMENT POUR ÉVITER LES RAYURES

Afin d'éviter les rayures, ce meuble doit être monté sur une surface souple (un tapis, par exemple).

LV: BRĪDINĀJUMS PAR SKRĀPĒJUMIEM!

Lai nesaskrāpētu šo izstrādājumu, veiciet montāžu uz mīkstas pamatnes, piemēram, paklāja.

LT: ĮSPĖJIMAS, KAD IŠVENGTUMĖTE ĮBRĖŽIMŲ!

Šio baldso nesubraižysite, jei jį surinksite ant švelnaus paviršiaus, pavyzdžiui, kilimo.

EE: HOIATUS KRIIMUSTUSTE VÄLTIMISEKS!

Kriimustuste tekkimise vältimiseks mööblile tuleb see kokku panna pehmel pinnal, nt kaltsuvaibal.

RU: ПРЕДУПРЕЖДЕНИЕ ОТНОСИТЕЛЬНО ЦАРАПИН!

Во избежание нанесения царапин, сборку этой мебели необходимо выполнять на мягкой поверхности, например на ковре.



EN: IMPORTANT!

It is important that any product which is assembled using any kind of screw is re-tightened 2 weeks after assembly, and once every 3 months - in order to assure stability through-out the lifespan of the product.

FR: IMPORTANT

Il est important que tout produit monté à l'aide de vis soit resserré 2 semaines après son montage, puis tous les 3 mois, afin de garantir sa stabilité durant tout son cycle de vie.

LV: SVARĪGI!

Ir svarīgi, lai jebkuram produktam, kas tiek uzstādīts ar jebkādu skrūvju palīdzību, skrūves tiktu atkārtoti pievilktas 2 nedēļas pēc montāžas, pēc tam – reizi 3 mēnešos, tā nodrošinot stabilitāti visā izstrādājuma kalpošanas laikā.

LT: SVARBU!

Bet kokį varžtais tvirtinamą gaminį 2 savaites po surinkimo bei kas 3 mėnesius reikia papildomai suveržti – taip užtikrinamas naudojamo gaminio stabilumas.

EE: TÄHTIS!

Oluline on, et toote kruvisid pingutataks 2 nädalat pärast kokkupanekut ja seejärel iga 3 kuu järel, et tagada stabiilsus kogu toote eluea jooksul.

RU: ВАЖНО!

В любом изделии, собранном с использованием винтов любого типа, необходимо через 2 недели после сборки и в дальнейшем каждые 3 месяца подтягивать винты, чтобы обеспечить прочность изделия в течение срока эксплуатации.





EN: GENERAL INSTRUCTION FOR FURNITURE MADE OF WOOD OR WOOD COMPOSITES SUCH AS MELAMINE, LAMINATE OR VENEER SURFACES!

*Wipe clean with a damp cloth. Use only water or a gentle detergent.
Wipe dry with a clean cloth.*

FR: INSTRUCTIONS GÉNÉRALES POUR LE MOBILIER CONSTITUÉ DE BOIS OU DE COMPOSITES DE BOIS (COMME LES SURFACES EN MELAMINÉ, STRATIFIÉ OU PLACAGE)

*Nettoyer à l'aide d'un chiffon humide. Utiliser uniquement de l'eau ou un détergent doux.
Essuyer à l'aide d'un chiffon propre.*

LV: VISPĀRĒJI NORĀDĪJUMI MĒBELĒM NO KOKA VAI KOKSNES KOMPOZĪTIEM, PIEMĒRAM, MELAMĪNA, LAMINĀTA VAI FINIERA VIRSMĀM!

*Noslaukiet ar mitru drānu. Lietojiet tikai ūdeni vai maigu mazgāšanas līdzekli.
Nosusiniet ar tīru drānu.*

LT: BALDŲ IŠ MEDIENOS AR MEDIENOS KOMPOZITO, DENGTO MELAMINU, LAMINATU AR PLONU FANEROS SLUOKSNIU, BENDRIEJI VALYMO NURODYMAI!

*Valykite drėgnu skudurėliu. Naudokite tik vandenį arba švelnų valiklį.
Nusausinkite švari skudurėliu.*

EE: PUIDUST VÕI MITMEKIHILISEST PUIDUST, NAGU MELAMIINIST, LAMINAADIST VÕI VINEERIST MÖÖBLI ÜLDJUHISED!

*Kasutage puhastamiseks niisket lappi. Kasutage ainult vett või õrnatoimelist puhastusvahendit.
Pühkige puhta lapiga kuivaks.*

RU: ОБЩИЕ УКАЗАНИЯ ОТНОСИТЕЛЬНО МЕБЕЛИ, ИЗГОТОВЛЕННОЙ ИЗ ДЕРЕВА ИЛИ ДРЕВЕСНЫХ КОМПОЗИЦИОННЫХ МАТЕРИАЛОВ, ТАКИХ КАК МЕЛАМИН, ЛАМИНАТ ИЛИ ШПОН!

*Очистите изделие чистой влажной тканью. Используйте мягкодействующее моющее средство.
Вытрите досуха чистой тряпкой.*

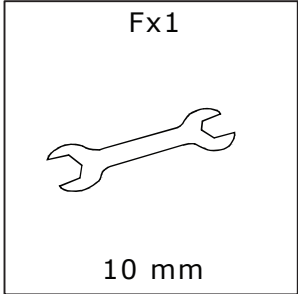
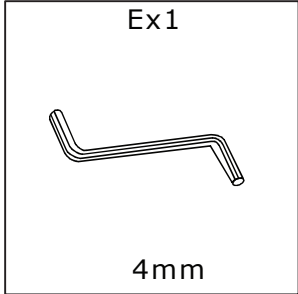
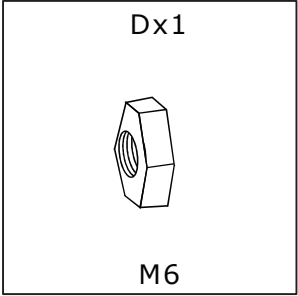
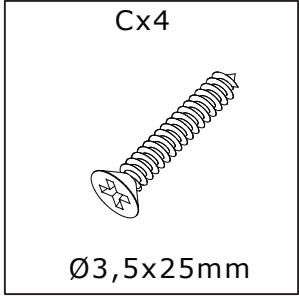
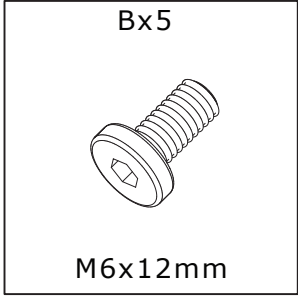
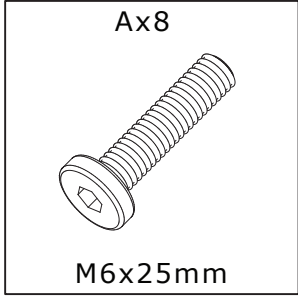
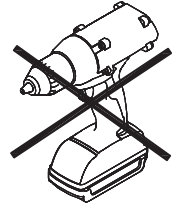
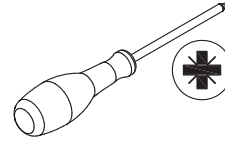

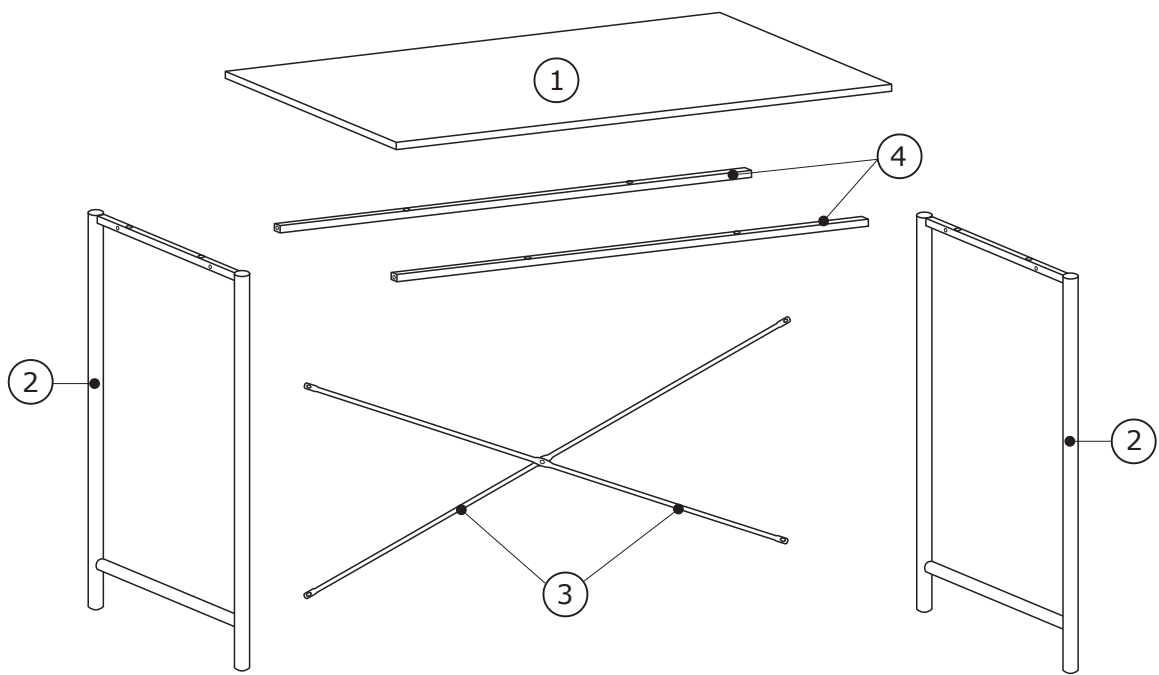

Box 1/1:

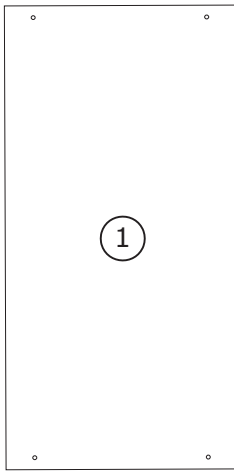

1200x600x15mm

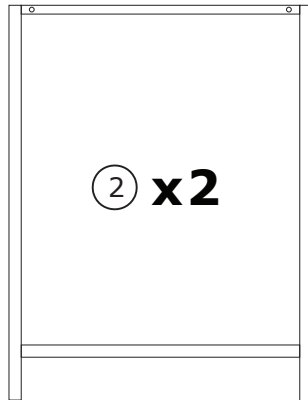

735x560x22mm

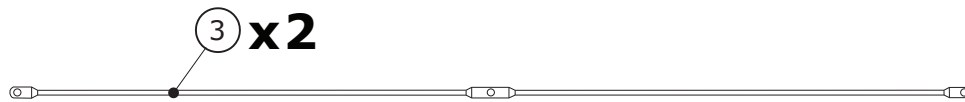

Ø6x1220mm

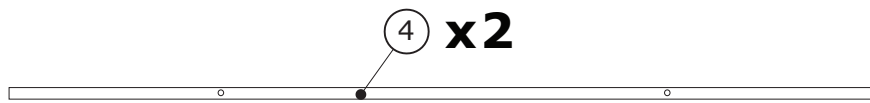

1121x15x15x0,8 mm

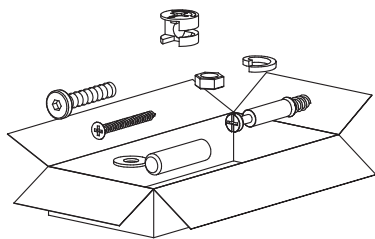



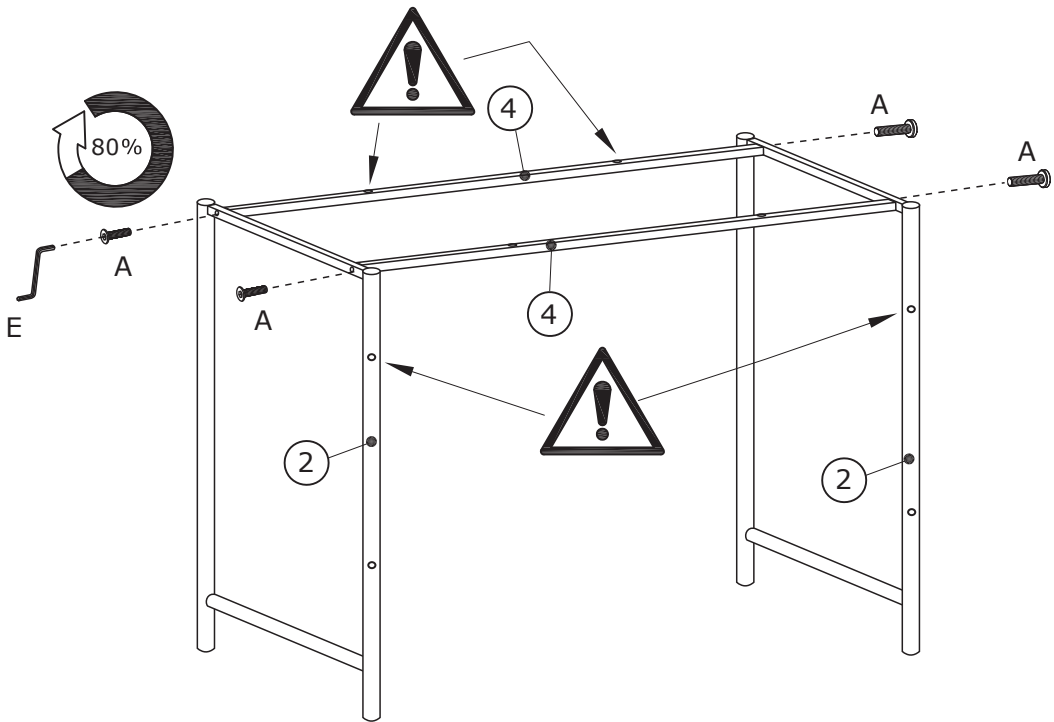

1

Ax4  M6x25mm	Ex1  4mm	
---	---	--

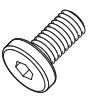

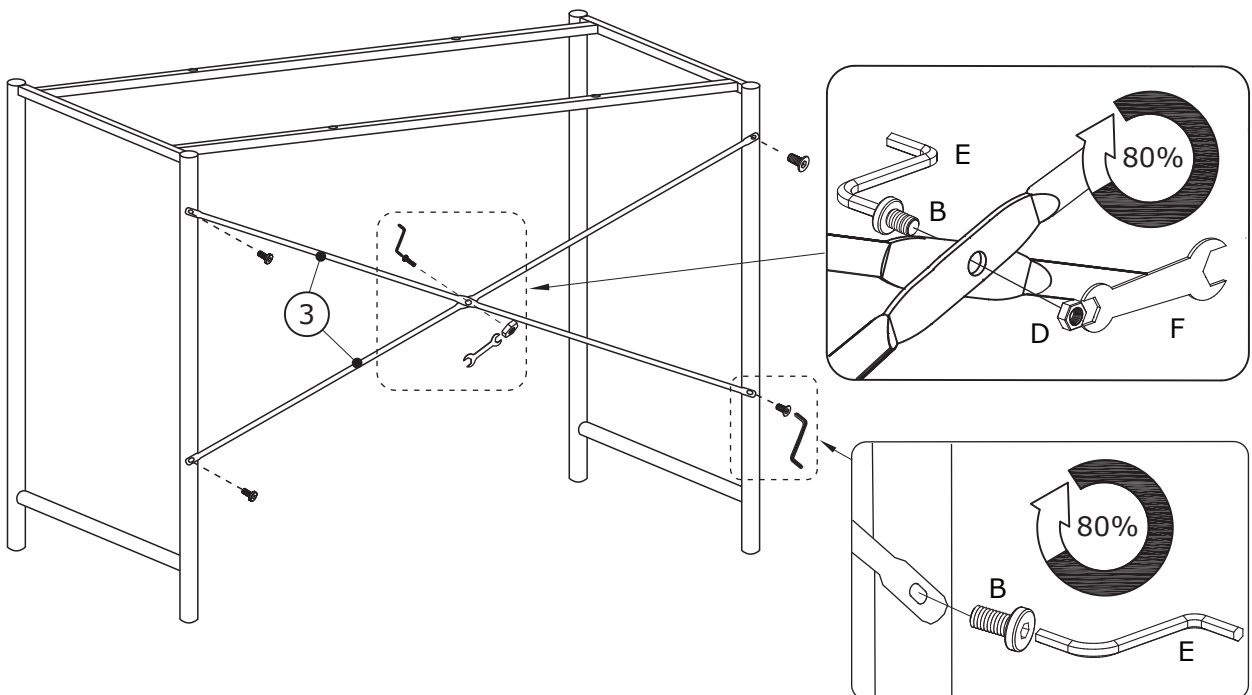

2

Bx5  M6x12mm	Dx1  M6	Ex1  4 mm	Fx1  10 mm	
---	--	--	---	--

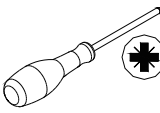

3

Ax4  M6x25mm	Cx4  Ø3,5x25mm	Ex1  4 mm	
---	---	--	---

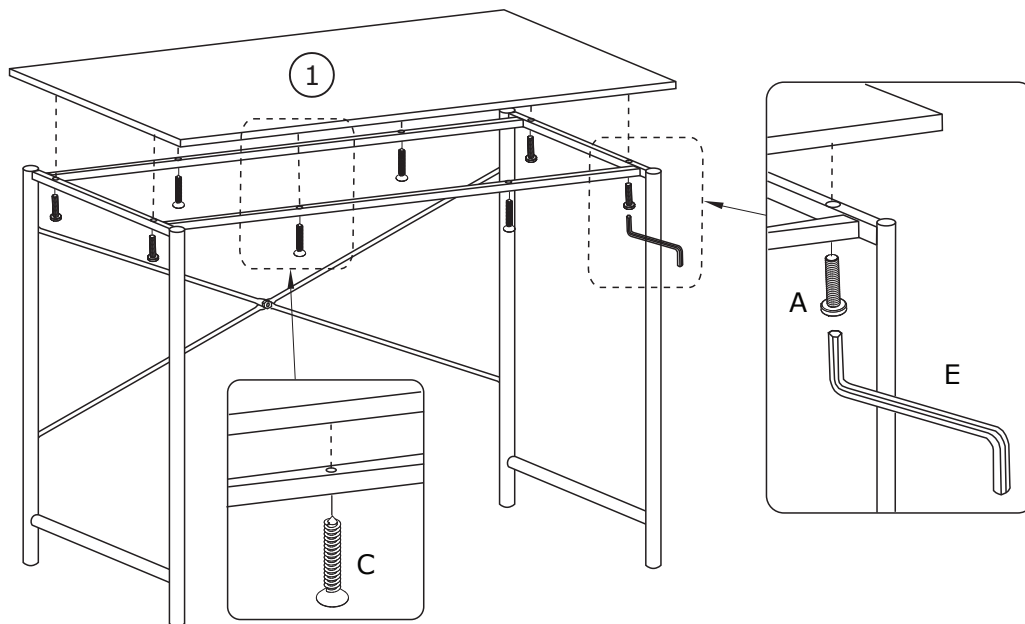
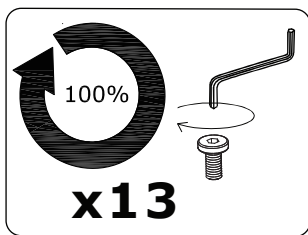

4

